

TUNE-R

Control Damper



Table of Contents

Description	3
Dimensions & Weights	5
Ordering Codes	7
Technical Parameters	8
Installation	11
Transport, Storage and Operation	12
Supplement	13



Description

TUNE-R is a control damper. The product is intended for air volume control of supply or extract. The product is installed into circular ducts. The product comes in manual or motorized version with integrated optical position indicator. The field of application is offices, hotel rooms or meeting rooms, health care premisses, residentials, etc., where the required ventilation, cooling or heating load will vary on demand.

Highlights

- Short compact casing
- Tightness class 4C up to 1000 Pa acc. to EN1751
- Manual version can be equipped by an actuator

Design

TUNE-R is manufactured from galvanized steel sheet. The product consists of two duct connections and an adjustable damper. All gaskets are manufactured from black rubber. Plastic bushings are from PPO material. All materials are flame retardant.

Tightness class versions acc. to EN 1751

- 1 - (A1) Casing tightness class A & blade tightness class 1 (no rubber gasket on inlet and no rubber gasket on blade)
- 2 - (C1) Casing tightness class C & blade tightness class 1 (rubber gasket on inlet and no rubber gasket on blade)
- 3 - (C4) Casing tightness class C & blade tightness class 4 (rubber gasket on inlet and rubber gasket on blade)

Types of Activation

- H - handle (hand operated)
- M0 - preparation for actuator, handle attached
- M1 - 230 V rotary actuator
- M2 - 24 V rotary actuator
- M3 - 24 V, 0 V ... 10 V stepless actuator
- M4 - 230 V spring return actuator
- M5 - 24 V spring return actuator
- M6 - 24 V, 0 V ... 10 V stepless spring return actuator

Product Parts

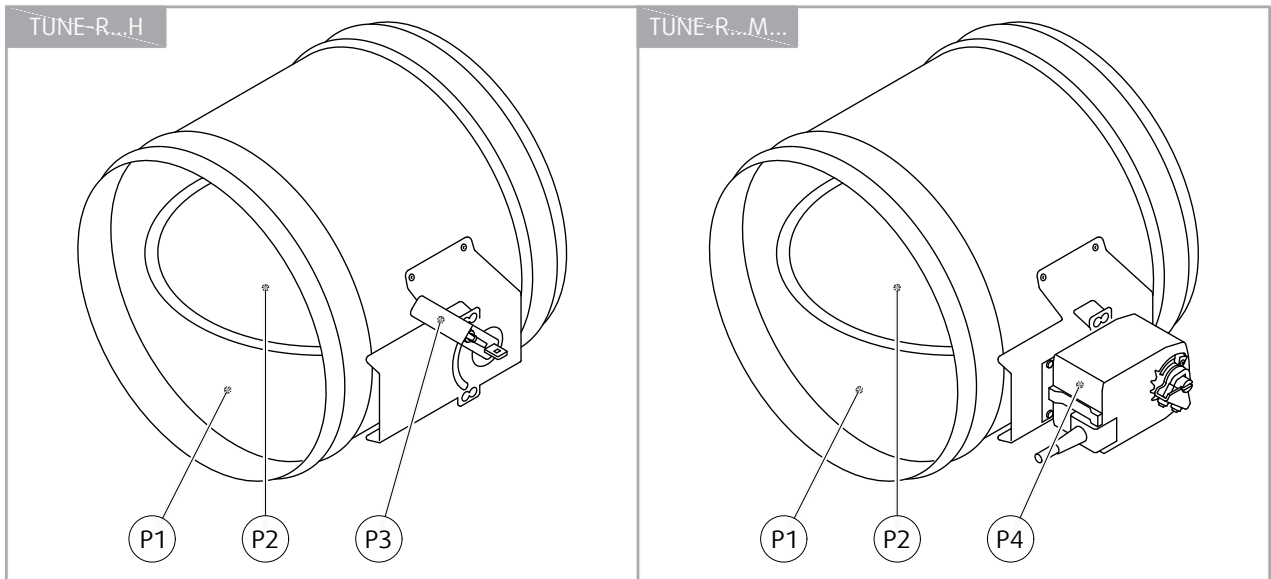

Legend

- P1 Casing
- P2 Damper blade
- P3 Manual mechanism
- P4 Actuator

Dimensions & Weights

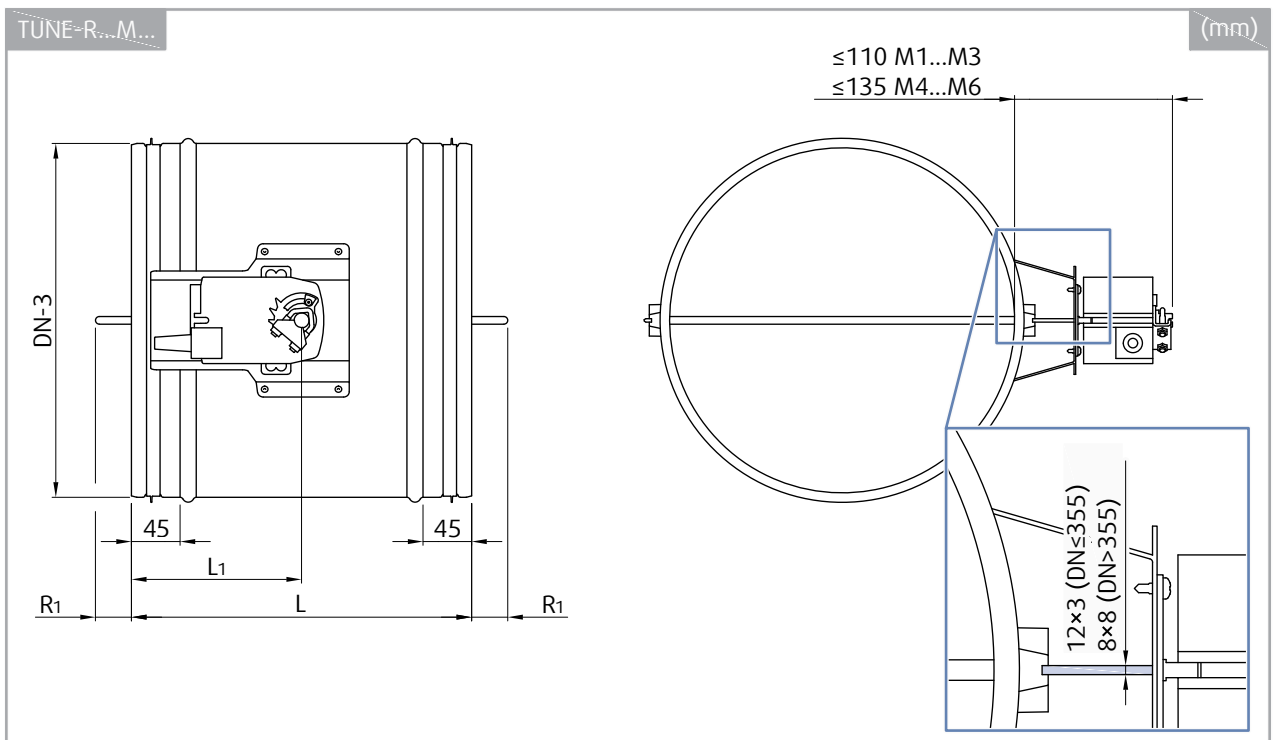
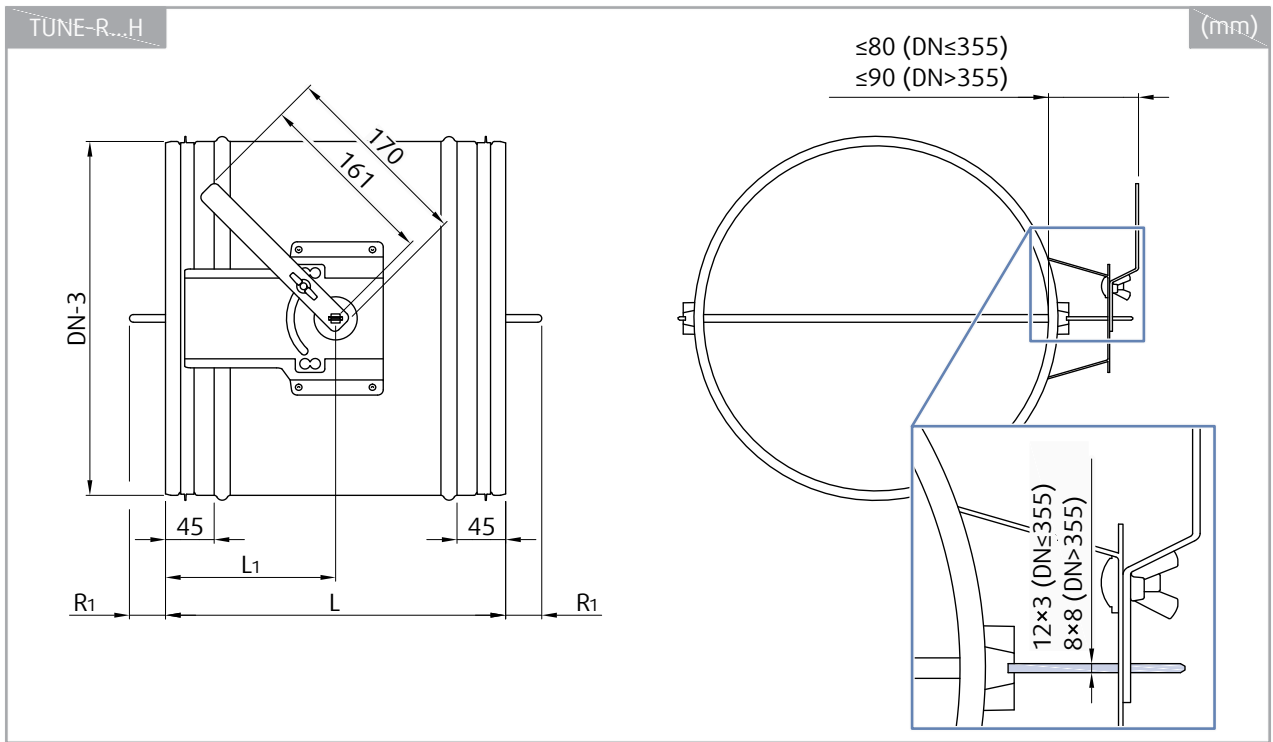

DN	L	L ₁	R1	m
	mm			kg
80	200	100	-60,5	0,9
100			-50	1
125			-37,5	1,1
140			-30	1,2
160			-20	1,3
180			-10	1,4
200			0	1,5
250			25	2,1
280	300	150	-10	3,2
315			7,5	3,7
355			27,5	4,2
400			50	6,1
450	400	200	25	8,1
500			50	9,3
560			80	10,8
630			115	12,7

Ordering Codes

TUNE-R-

Diameter

80 mm ... 630 mm

Tightness class

1 A1

2 C1

3 C4

Version

H Handle (hand operated)

M0 Preparation for actuator

M1 230 V actuator

M2 24 V actuator

M3 24 V, 0 V ... 10V stepless actuator

M4 230 V spring actuator

M5 24 V spring actuator

M6 24 V, 0 V ... 10V stepless spring actuator

Stainless steel (optional)

A316 For general usage

Example of the Ordering Code

TUNE-R-160-2-M3-A316

TUNE-R control damper; size (diameter) 160 mm, tightness class C1, 24 V stepless actuator with an analog control mechanism DC 0 V ... 10V, manufactured from stainless steel A-316.

Technical Parameters

TUNE-R-080-1-M...

Pressure drop & A-weighted sound power level in dB(A)

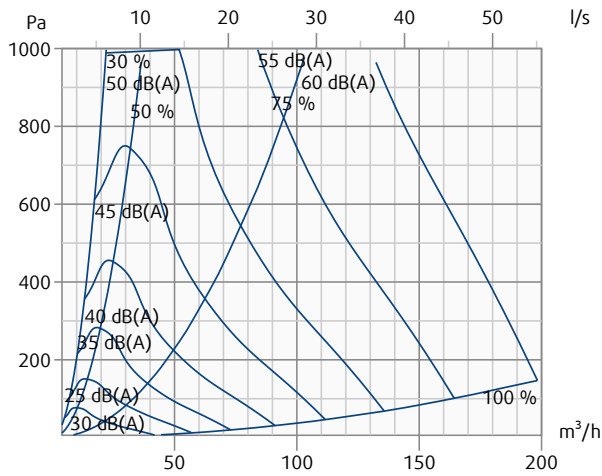

TUNE-R-100-1-M...

Pressure drop & A-weighted sound power level in dB(A)

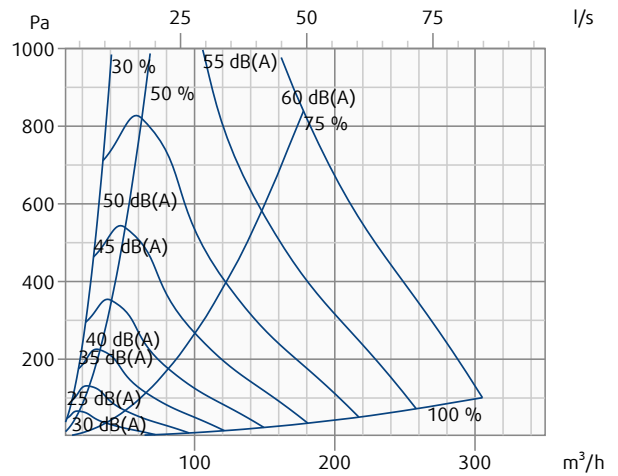

TUNE-R-125-1-M...

Pressure drop & A-weighted sound power level in dB(A)

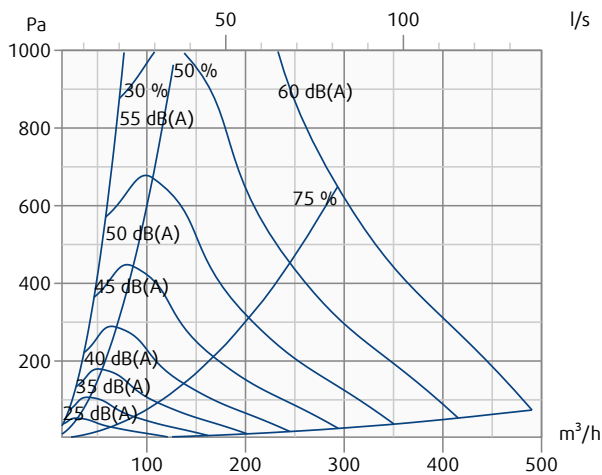

TUNE-R-140-1-M...

Pressure drop & A-weighted sound power level in dB(A)

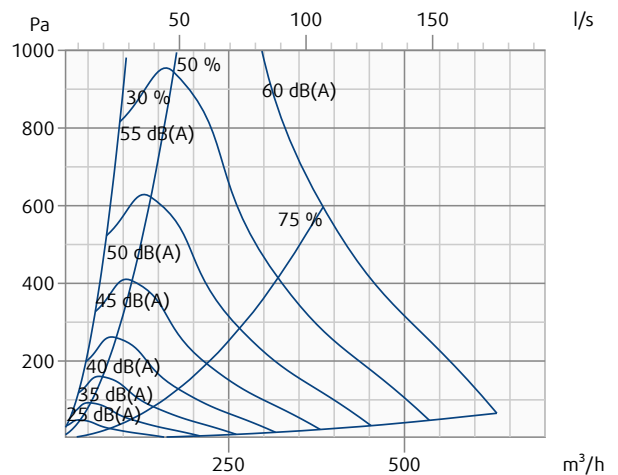

TUNE-R-160-1-M...

Pressure drop & A-weighted sound power level in dB(A)

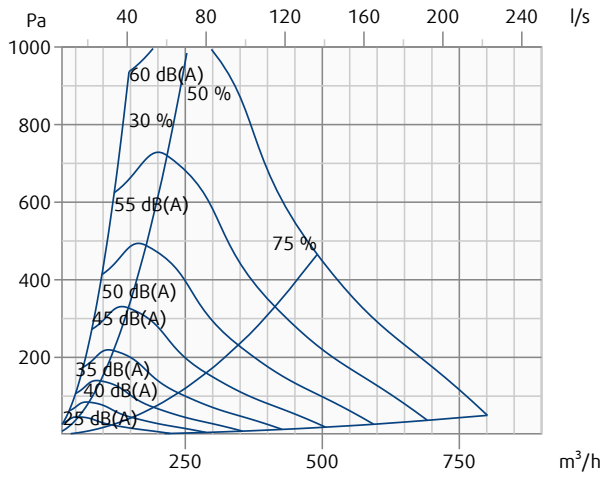

TUNE-R-180-1-M...

Pressure drop & A-weighted sound power level in dB(A)

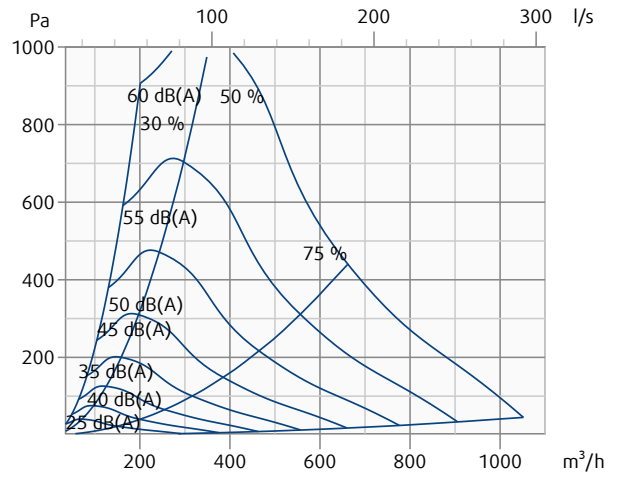

TUNE-R-200-1-M...

Pressure drop & A-weighted sound power level in dB(A)

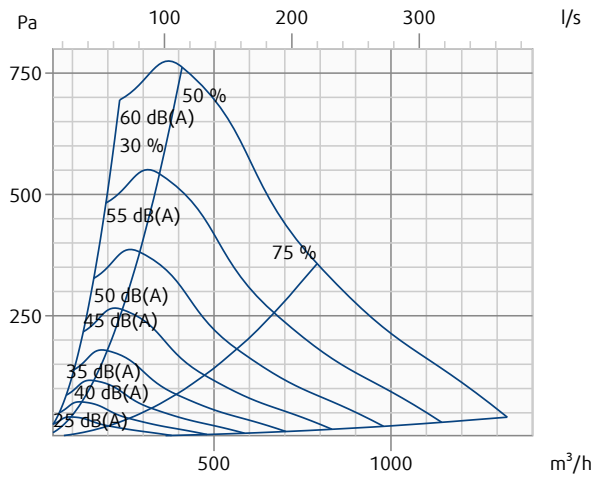

TUNE-R-280-1-M...

Pressure drop & A-weighted sound power level in dB(A)

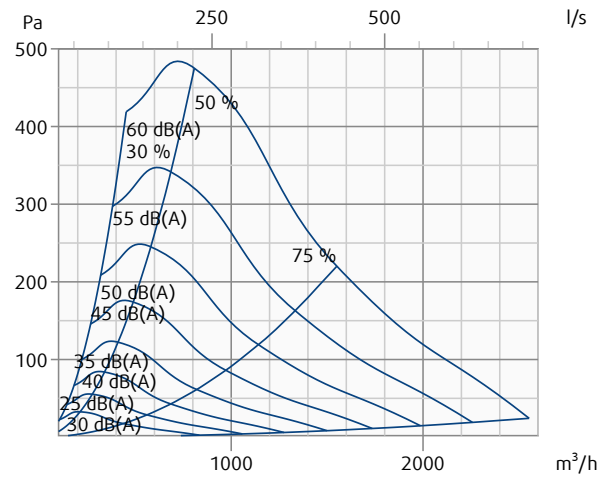

TUNE-R-315-1-M...

Pressure drop & A-weighted sound power level in dB(A)

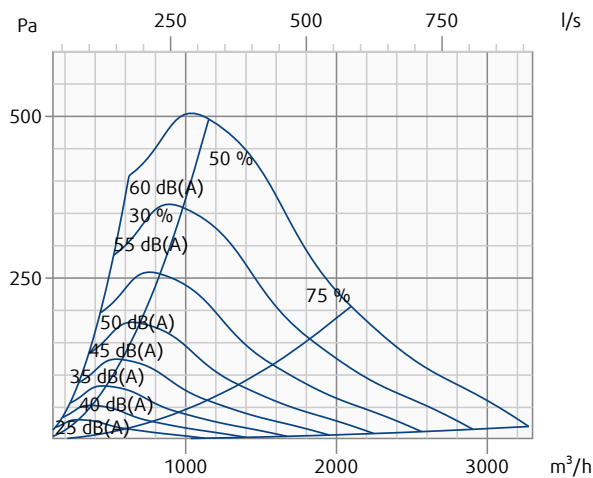

TUNE-R-400-1-M...

Pressure drop & A-weighted sound power level in dB(A)

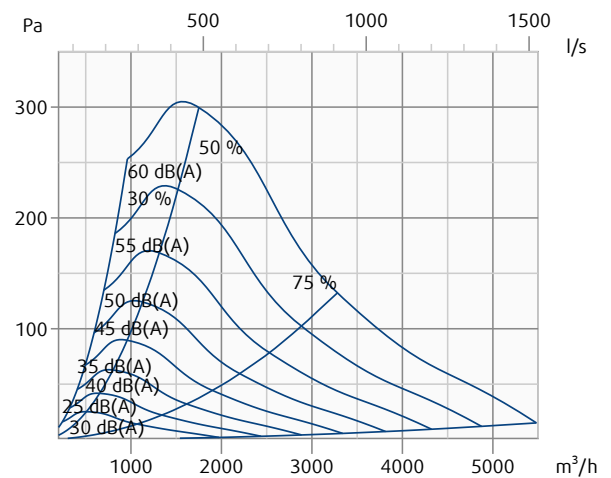

TUNE-R-450-1-M...

Pressure drop & A-weighted sound power level in dB(A)

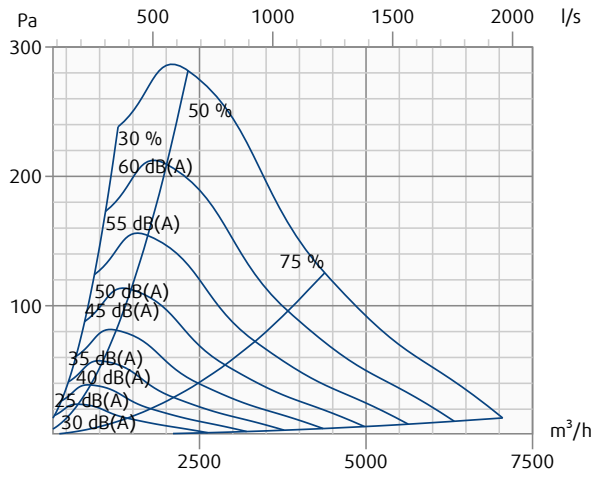

TUNE-R-500-1-M...

Pressure drop & A-weighted sound power level in dB(A)

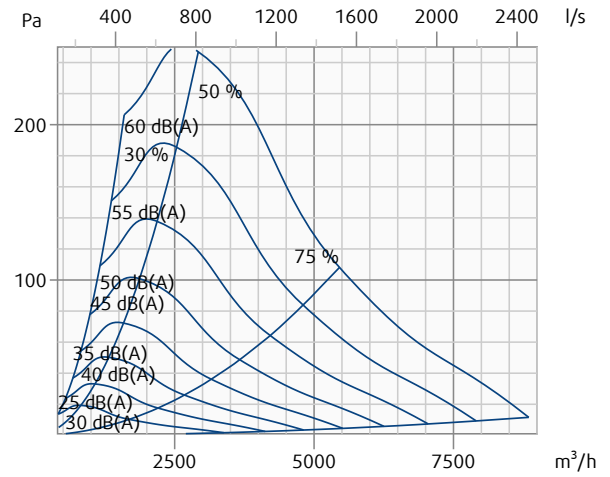

TUNE-R-560-1-M...

Pressure drop & A-weighted sound power level in dB(A)

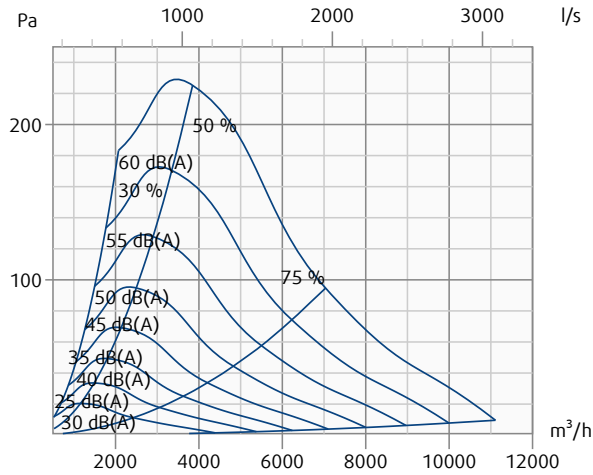

TUNE-R-630-1-M...

Pressure drop & A-weighted sound power level in dB(A)

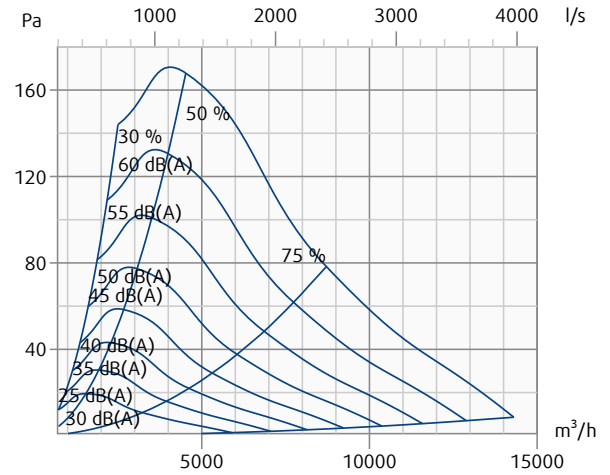



Installation

TUNE-R has two duct connections with gasket, foreseen to slide into the rigid air duct until the mechanical stop ring on the damper reaches the duct edge. When the connected ductwork is fixed in place after installation, no additional fixing of the damper is required. The damper cannot be installed carrying any mechanical loads from other structures.

Transport, Storage and Operation

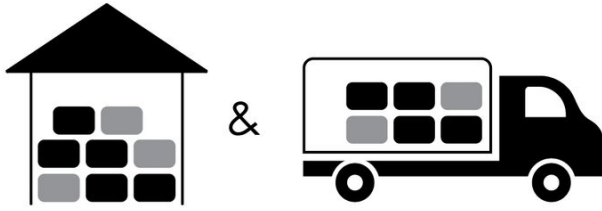
For type of actuation H and M0



 °C -40 °C ... +50 °C

 % ≤ 95%



 °C -20 °C ... +70 °C

 % ≤ 95%

For type of actuation M1...M6

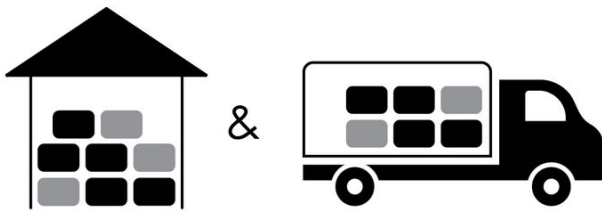

 °C -40 °C ... +50 °C

 % ≤ 95%



 °C -20 °C ... +50 °C

 % ≤ 95%

Supplement

Any deviations from the technical specifications contained herein and the terms should be discussed with the manufacturer. We reserve the right to make any changes to the product without prior notice, provided that these changes do not affect the quality of the product and the required parameters. Current information on all products is available on design.systemair.com



Handbook_TUNE_R_en-GB

design.systemair.com

www.systemair.com

© Copyright Systemair Production a.s

All rights reserved

E&OE

Systemair reserves the right to alter their products without notice.

This also applies to products already ordered, as long as it does not affect the previously agreed specifications.